

DWG R-1287

REVISION HISTORY

REV	DESCRIPTION	DATE	APPROVED
1			

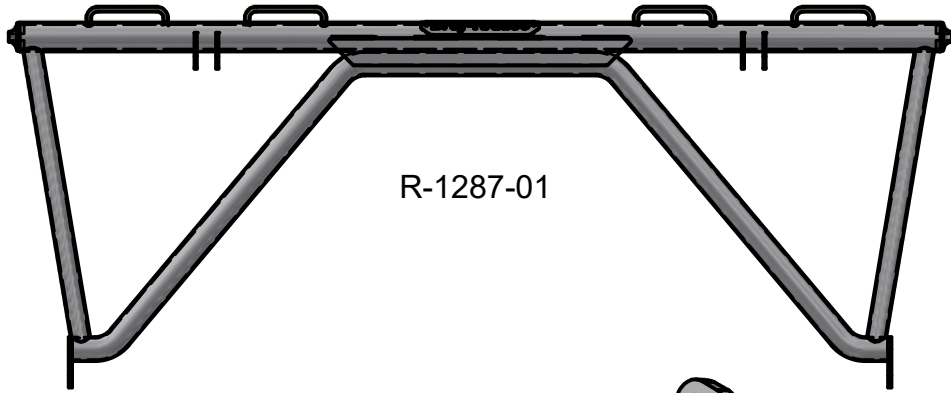

R-1287-01

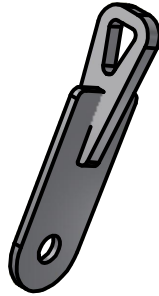

R-1287-08
(2x)



R-1287-02

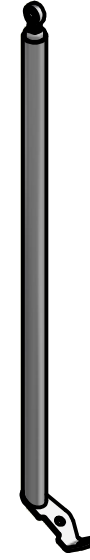

R-1287-03

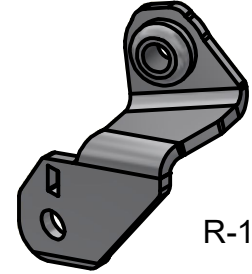

R-1287-05

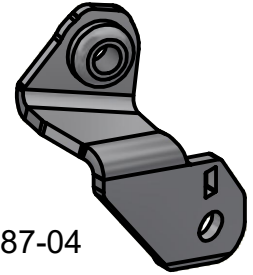

R-1287-04

R-1287-HW

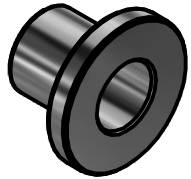

R-1287-09
(2x)

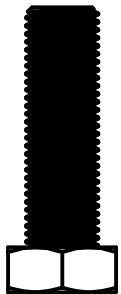

M-0392-20
(2x)

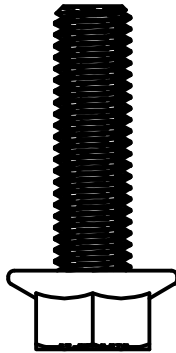

M-9508-35
(2x)

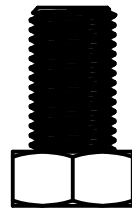

M-0391-12
(2x)

TOLERANCES <small>(UNLESS OTHERWISE SPECIFIED)</small> Δ : $\pm 1^\circ$ FRACTIONAL : $\pm \frac{1}{64}$ " X.XX : ± 0.010 X.XXX : ± 0.005 X.XXXX : ± 0.0002	
<small>DRAWN</small> ilindvig	3/20/2017
<small>CHECKED</small>	
<small>RELEASE</small>	
<small>APPROVED</small>	

		BREY-KRAUSE MFG. 1209 W. LEHIGH STREET BETHLEHEM, PA 18018	
R-1287 Packing			
<small>SIZE</small> A	<small>DWG NO.</small> R-1287	<small>REV</small> 1	
<small>SCALE</small> 1 : 1		SHEET 1 OF 1	

THIS DRAWING IS PROPRIETARY AND CONFIDENTIAL The information contained in this drawing is the sole property of Brey-Krause Mfg. Any reproduction, in part or as a whole without the permission of Brey-Krause Mfg. is prohibited.